



The **Australian** Showcase Company



Quadrant



LVSL



FLDF



LVDL



FLSH

The range described in this leaflet is based on the Quadrant aluminium cabinet-framing system.

This method of construction combines good looks with exceptional strength and design flexibility.

All the units shown are available at short notice, with a wide choice of variations. They can be supplied complete and ready for use; or can be ordered by trade assemblers in component form.

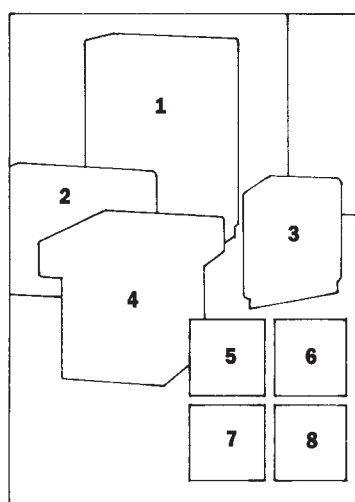

- 1) SQ TSB 12A (P4)
- 2) SQ CGL 12A (Modified base: P4)
- 3) SQ CAG 06F (P6)
- 4) SQ MUS 09S (P9)
- 5) Low voltage spot lamp
- 6) Diffuser grid for fluorescents
- 7) Low voltage downlighter
- 8) Shaded fluorescent

Specification details

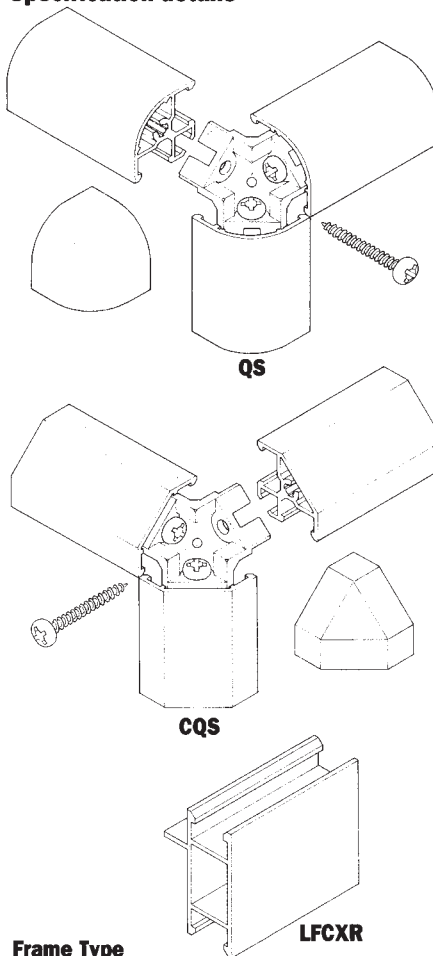

Frame Type

The external frame comes in two variants: Radiused (**QS**) or Chamfered (**CQS**), both 30mm deep, and functionally alike. Subdivisions are made with a flat-fronted rail (**LFCXR**) 45mm deep.

Metal Finish

Frames have an anodised finish (satin silver AA5), or may be epoxy coated with any of twelve standard colours: see back cover for references.

Plastic Sections

Glazing beads, sliding door track and flanges for hinged glass doors are in plastic, and available in dark grey or black. Grey is default, and supplied if no colour is specified.

Timber Panels

The standard material for timber infills is a 12mm thick lightly textured melamine-faced board in either light grey or black. Laminate-faced or painted MDF panels may be substituted to special order.

Glazing

Infills and shelves less than 700mm wide are in 6mm float glass. Shelves wider than 700mm are in 8mm float glass. All

exposed edges are polished. Toughened or laminated glass may be substituted for float glass to special order.

Plinths

The standard Plinth is 100mm high, made of 18mm ply, and finished in black nairnclad. Integral levellers provide up to 30mm of adjustment. This plinth is supplied with all units except for wall-hung and tank-top units.

Plinths in other materials and heights may be supplied to special order.

Storage Base

The standard Storage Base is a panelled section beneath the display area, fitted with a lockable door and shelf. Additional shelves may be ordered (see p. 9 for references).

Doors and Locks

Doors used in apertures with a width of 750mm or less are hinged; in apertures wider than 750mm, doors are sliding.

All doors are lockable. Unless specified otherwise, locks for hinged doors are keyed alike to a standard pattern for which keys are available from stock. Locks for sliding doors are individually keyed.

Lighting

Most design types allow for lighting, and either fluorescent or low-voltage tungsten is available. The fittings (see opposite) are designed for optimum performance in showcases, and four types are offered:

LVSL. Low voltage spotlights. These adjustable-head lamps take standard 20W metal reflector 48mm 64 base bulbs, and are fixed to the inside of the frame. (NOTE: Internal spotlamps generate heat, and should be specified with caution).

LVDL. Low voltage downlighters. These lamps, fitted to a soffit panel in the fascia section, take standard 20W MR16 dichroic reflector bulbs, and are adjustable for angle and direction.

FLSH. Shaded fluorescents. The tube is fitted to the inside of the top front rail, and housed in an unobtrusive aluminium shade which matches the frame.

FLDF. Diffused fluorescents. Multiple tubes are fitted in the fascia section, and diffused with a white plastic grid.

Power Feed

Unless specified otherwise, the power feed for lighting is provided via 3m of cable, emerging at left back of the base.

DIMENSIONS

Dimensions are standard throughout the range. These are summarised below, and the design types to which they are applicable are indicated.

Height dimensions

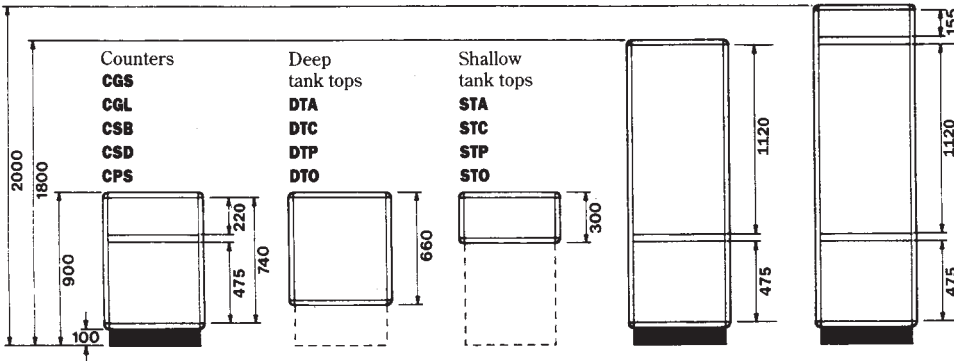

Width dimensions

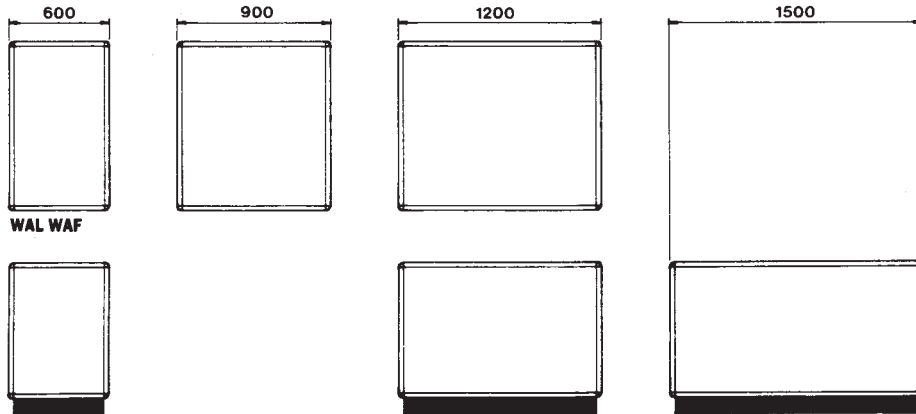

TGL TSB TGF TSF CGS CGL CSB CSD CPS STA DTA WSG WSS WSF WSB

Plan dimensions

To help with the calculation of overall group dimensions, the plan shapes are shown with a 300mm grid superimposed. Note however that when units are linked with spacers (see right), the overall width

of a group will exceed the nominal total by 10mm per junction.

If overall group dimensions are critical, please consult us early, so that the best design approach can be found.

Towers and Counters



Wall-hung units



Wall-standing units

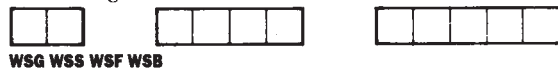

Corner units

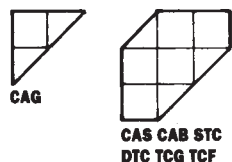

Offset-link units



Prow units



Bay-front units



Wall-hung units

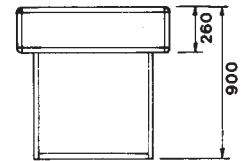
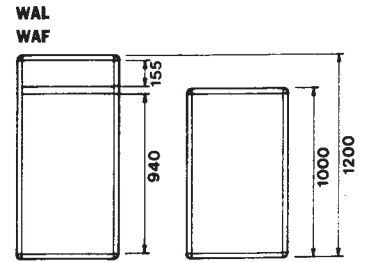

Mushroom units

MUS MUB

Lateral linking

The standard specification is based on stand-alone use, with glazing on all four faces.

If units need to be physically joined, the following approach is recommended:

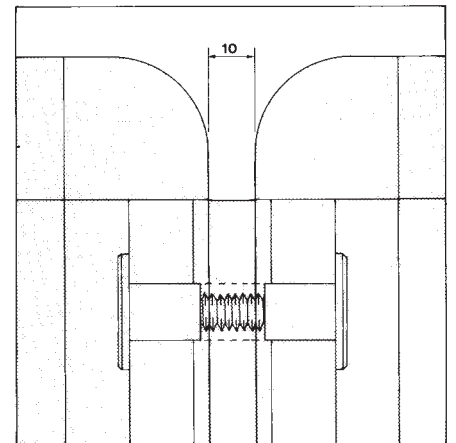

- (a) substitute a single timber panel for the existing infills in each lateral face;
- (b) introduce an 18mm spacer panel to provide a 10mm gap;
- (c) bolt the adjacent panels together.

Lateral linking may be specified at no additional charge: a spacer panel and set of bolts will be supplied with each unit thus specified. The default colour for spacer panels is black.

Where a unit is to be used at the end of a run, lateral linking may be specified for one side only, retaining the original infills on the other: if so, a sketch must be provided to show clearly the required configuration.

Typical group combinations

Counters with **CAG** corner infill.

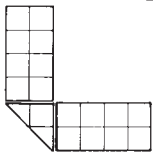
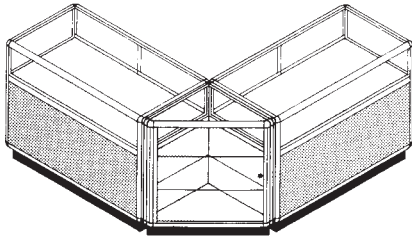

Counters with **CAS** corner unit.

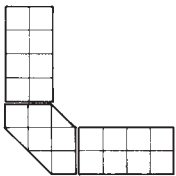
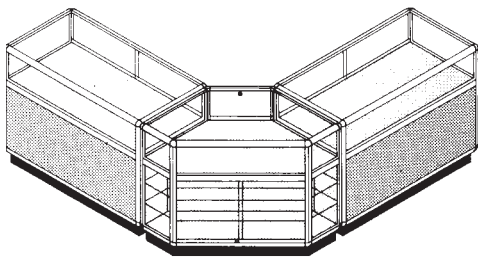

Counters with **TSF** tower at corner.

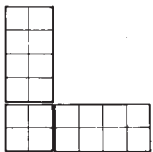
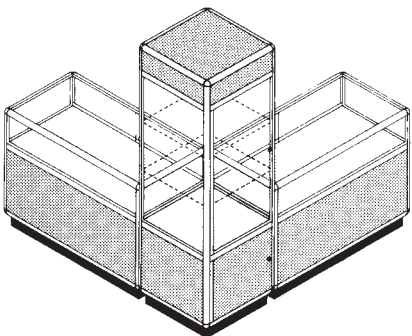

Counters with **TPS** Tower Prow unit.

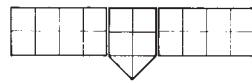
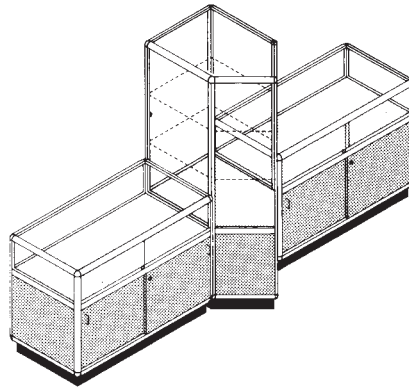

Counters with **COS** Offset unit.

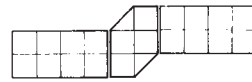
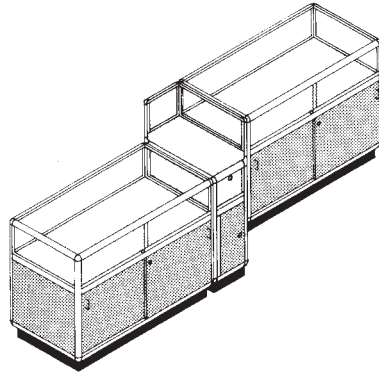

WSS Wall standing case with **WBS** Bay-front unit.

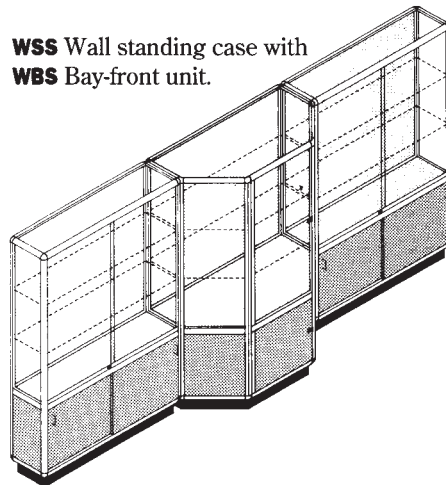

How to order

Using the Standard Unit order form will ensure that we have all the information we need.

If this is not possible, we must be provided with information about your requirements under two headings:

1. General specification.

Identify frame type, and colours for frame sections and timber panels.

2. Unit references.

Itemise units with the required lighting options; and add separate references for shelves as required. (Unless they are specifically included in the unit description, shelves must be added as separate references.)

Unit references:	Quantity
SQ CSB 12F 1200mm Counter	2
SQ TSF 06F 600mm Tower	1
SQ CAS 09F Corner unit	1
SQ SHG 06A Glass shelf	2
SQ SHT 12A Timber shelf	2

Example:

General specification:

Frame type	: CQS Chamfered
Metal finish	: Black
Plastic sections	: Black
Timber panels	: Light grey

Non-standard variations

If the standard options are not suitable, special variations can be ordered, but must be individually specified and costed.

Typical design variations include dimensional changes; the introduction of non-standard infills such as laminated panels or toughened glass; and the addition of special lamps, locks or other internal fittings.

The cost implications of design variations will depend on the nature of the changes, and the number of units required. We will be glad to advise.

TOWERS

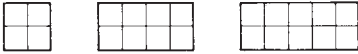

TGL – Tower case fully glazed.

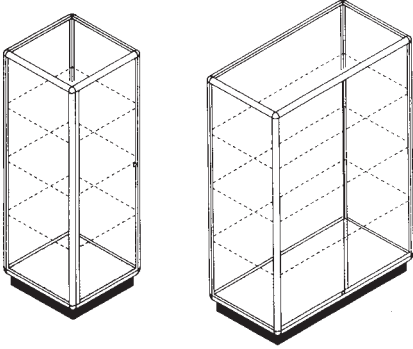

Unit ref.	Width	Lamps	No.	Watts
SQ TGL 06A	600		–	–
" 06L	"	LVSL	2	40
" 12A	1200		–	–
" 12L	"	LVSL	4	80
" 15A	1500		–	–
" 15L	"	LVSL	6	120

TSB – Tower case with storage base.

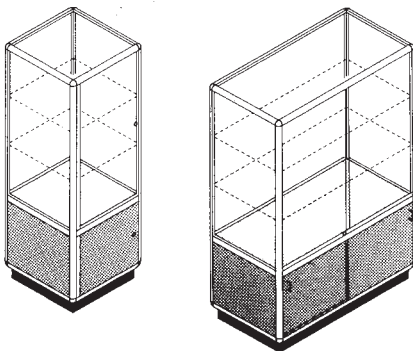

Unit ref.	Width	Lamps	No.	Watts
SQ TSB 06A	600		–	–
" 06L	"	LVSL	2	40
" 12A	1200		–	–
" 12L	"	LVSL	4	80
" 15A	1500		–	–
" 15L	"	LVSL	4	80

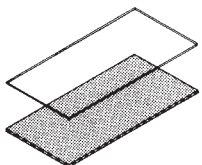

For shelves see P9.
For dimensions see P2.

TGF – Tower case with fascia.

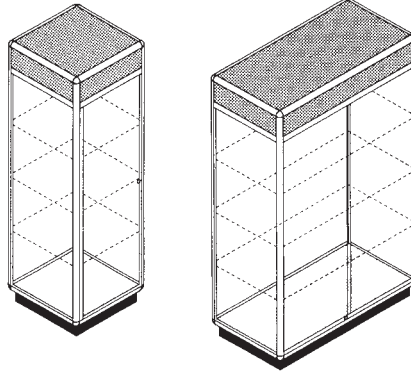

Unit ref.	Width	Lamps	No.	Watts
SQ TGF 06F	600	FLDF	2	30
" 06D	"	LVDL	2	40
" 12F	1200	FLDF	2	60
" 12D	"	LVDL	4	80
" 15F	1500	FLDF	2	72
" 15D	"	LVDL	6	120

TSF – Tower case with storage base and fascia.

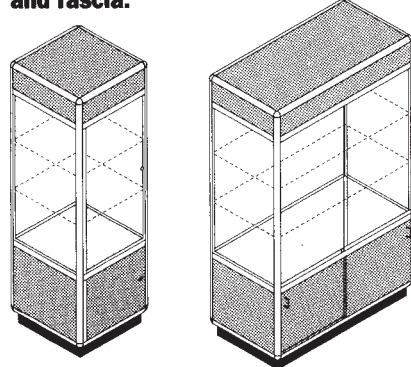

Unit ref.	Width	Lamps	No.	Watts
SQ TSF 06F	600	FLDF	2	30
" 06D	"	LVDL	2	40
" 12F	1200	FLDF	2	60
" 12D	"	LVDL	4	80
" 15F	1500	FLDF	2	72
" 15D	"	LVDL	6	120

COUNTERS



CGS – Counter fully glazed.

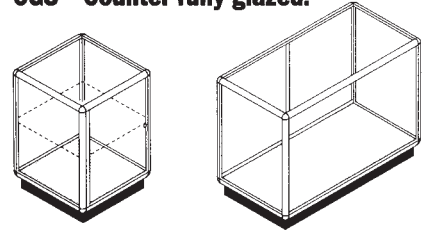

Unit ref.	Width	Lamps	No.	Watts
SQ CGS 06A	600		–	–
" 06F	"	FLSH	1	15
" 12A	1200		–	–
" 12F	"	FLSH	1	30
" 15A	1500		–	–
" 15F	"	FLSH	1	36

CGL – Counter fully glazed with rear shelf.

300mm deep shelf on cantilever brackets to rear.

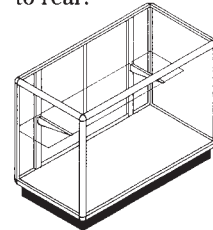

Unit ref.	Width	Lamps	No.	Watts
SQ CGL 12A	1200		–	–
" 12F	"	FLSH	1	30
" 15A	1500		–	–
" 15F	"	FLSH	1	36

CSB – Glazed counter with storage base.

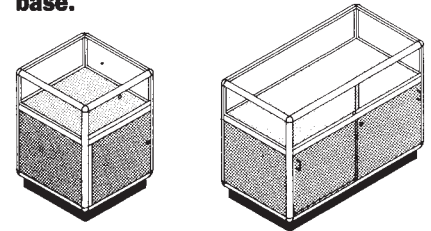

Unit ref.	Width	Lamps	No.	Watts
SQ CSB 06A	600		–	–
" 06F	"	FLSH	1	15
" 12A	1200		–	–
" 12F	"	FLSH	1	30
" 15A	1500		–	–
" 15F	"	FLSH	1	36

WALL-HUNG UNITS



CSD - Glazed counter with storage/ display base.

Display section at front of base fitted with two 200mm glass shelves; rear storage section with timber shelf.

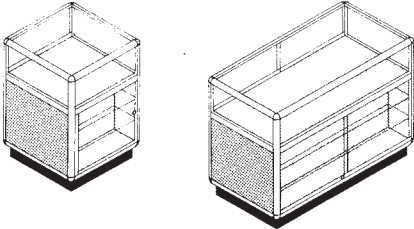

Unit ref.	Width	Lamps	No.	Watts
SQ CSD 06A	600	-	-	-
" 06F	"	FLSH	3	45
" 12A	1200	-	-	-
" 12F	"	FLSH	3	90
" 15A	1500	-	-	-
" 15F	"	FLSH	3	108

CPS - Panelled storage counter.

Door to rear. No lighting options.

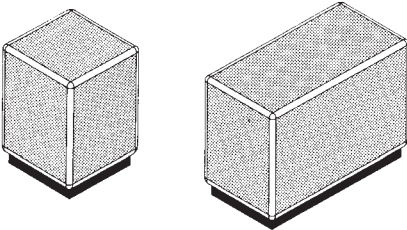

Unit ref.	Width
SQ CPS 06A	600
" 12A	1200
" 15A	1500

STA - Shallow glazed tank-top counter.

No plinth.

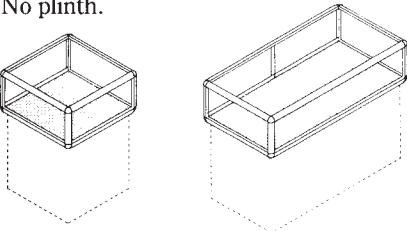

Unit ref.	Width	Lamps	No.	Watts
SQ STA 06A	600	-	-	-
" 06F	"	FLSH	1	15
" 12A	1200	-	-	-
" 12F	"	FLSH	1	30
" 15A	1500	-	-	-
" 15F	"	FLSH	1	36

DTA - Deep glazed tank-top counter.

No plinth.

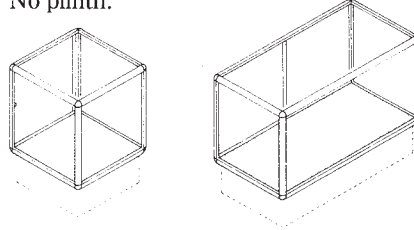

Unit ref.	Width	Lamps	No.	Watts
SQ DTA 06A	600	-	-	-
" 06F	"	FLSH	1	15
" 12A	1200	-	-	-
" 12F	"	FLSH	1	30
" 15A	1500	-	-	-
" 15F	"	FLSH	1	36

TIL - Till unit with base shelf.

Work surface is 650mm high, with 540mm internal width. Base storage section open-backed, and fitted with adjustable shelf. No lighting options.

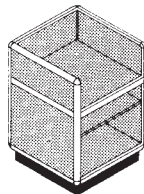

Unit ref.	Width
SQ TIL 06A	600

WAL - Wall-hung case fully glazed.

Supplied with pair of uprights and brackets for wall fixing. No lighting options.

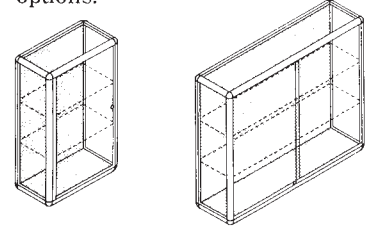

Unit ref.	Width
SQ WAL 06A	600
" 09A	900
" 12A	1200

WAF - Wall-hung case with fascia.

Supplied with pair of uprights and brackets for wall fixing.

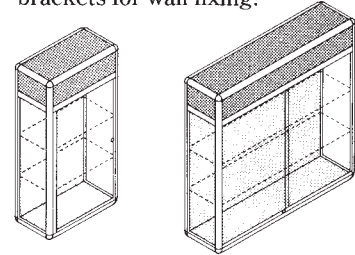

Unit ref.	Width	Lamps	No.	Watts
SQ WAF 06F	600	FLDF	1	15
" 06D	"	LVDL	2	40
" 09F	900	FLDF	1	18
" 09D	"	LVDL	2	40
" 12F	1200	FLDF	1	30
" 12D	"	LVDL	4	80

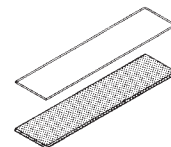

For shelves see P9.
For dimensions see P2.

WALL-STANDING UNITS

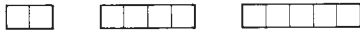

WSG - Wall-standing case fully glazed.

Timber back. Must be fixed to wall for stability. The 1500mm version is fitted with a shelf-support upright at centre back.

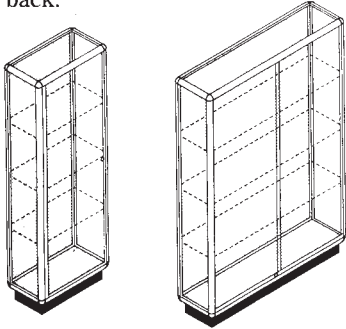

Unit ref.	Width	Lamps	No.	Watts
SQ WSG 06A	600	-	-	-
" 06L	"	LVSL	2	40
" 12A	1200	-	-	-
" 12L	"	LVSL	4	80
" 15A	1500	-	-	-
" 15L	"	LVSL	4	80

WSS - Wall-standing case with storage base.

Timber back. Must be fixed to wall for stability. The 1500mm version is fitted with a shelf-support upright at centre back.

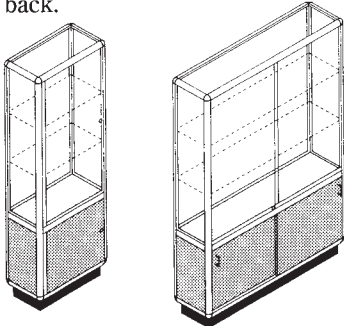

Unit ref.	Width	Lamps	No.	Watts
SQ WSS 06A	600	-	-	-
" 06L	"	LVSL	2	40
" 12A	1200	-	-	-
" 12L	"	LVSL	4	80
" 15A	1500	-	-	-
" 15L	"	LVSL	4	80

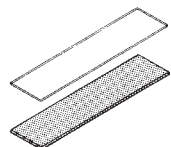

For shelves see P9.
For dimensions see P2.

WSF - Wall-standing case with fascia.

Timber back. Must be fixed to wall for stability. The 1500mm version is fitted with a shelf-support upright at centre back.

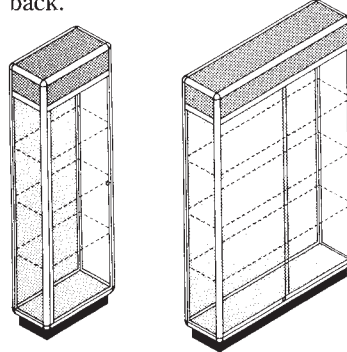

Unit ref.	Width	Lamps	No.	Watts
SQ WSF 06F	600	FLDF	1	15
" 06D	"	LVDL	2	40
" 12F	1200	FLDF	1	30
" 12D	"	LVDL	4	80
" 15F	1500	FLDF	1	36
" 15D	"	LVSL	4	80

WSB - Wall-standing case with storage and fascia.

Timber back. Must be fixed to wall for stability. The 1500mm version is fitted with a shelf-support upright at centre back.

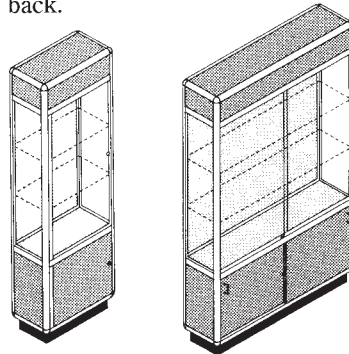

Unit ref.	Width	Lamps	No.	Watts
SQ WSB 06F	600	FLDF	1	15
" 06D	"	LVDL	2	40
" 12F	1200	FLDF	1	30
" 12D	"	LVDL	4	80
" 15F	1500	FLDF	1	36
" 15D	"	LVDL	4	80

CORNER UNITS

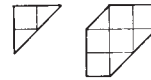

CAG - Corner infill counter fully glazed.

Supplied with two adjustable glass shelves. Access via hinged glass door. NB: For stability, this case must always be fixed to adjacent unit.

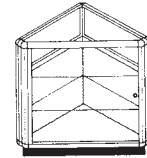

Unit ref.	Lamps	No.	Watts
SQ CAG 06A	-	-	-
" 06F	FLSH	1	15

CAS - Glazed corner counter with storage/display base.

Glazed lower display area in longer face; door to base storage in short face. Two glass shelves in lower display area, one timber shelf in storage area.

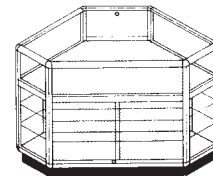

CAB - Reverse corner counter with storage/display base.

Similar to CAS, but with the lower display area and base storage reversed - i.e. door to base storage is in longer face. Two glass shelves and one timber shelf.

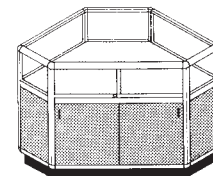

Unit ref.	Lamps	No.	Watts
SQ CAS 09A	-	-	-
" 09F	FLSH	1	15
SQ CAB 09A	-	-	-
" 09F	FLSH	1	15

PROW UNITS



STC - Shallow tank-top corner counter.
300mm high. No plinth.

DTC - Deep tank-top corner counter.
600mm high. No plinth.

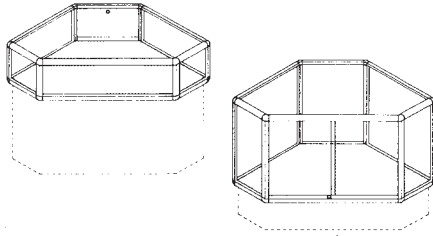

Unit ref.	Lamps	No.	Watts
SQ STC 09A	-	-	-
" 09F	FLSH	1	15
SQ DTC 09A	-	-	-
" 09F	FLSH	1	15

TCG - Tower corner fully glazed.

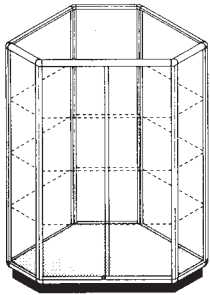

TCF - Tower corner glazed with fascia.

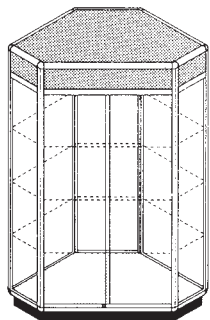

Unit ref.	Lamps	No.	Watts
SQ TCG 09A	-	-	-
" 09L	LVSL	4	80
SQ TCF 09D	LVDL	4	80
" 09F	FLDF	2	36

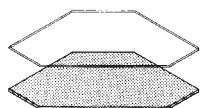

Shelves for corner units:
Glass - **SQ SHG 09C**
Timber - **SQ SHT 09C**

TPG - Tower prow unit fully glazed.

TPS - Tower prow unit with storage base.

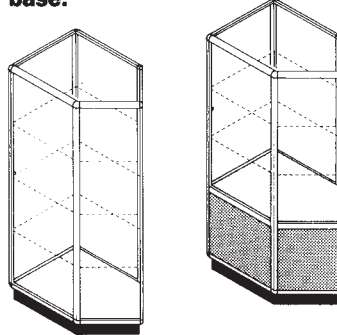

Unit ref.	Lamps	No.	Watts
SQ TPG 06A	-	-	-
" 06L	LVSL	4	80
SQ TPS 06A	-	-	-
" 06L	LVSL	4	80

TPF - Tower prow unit glazed with fascia.

TPB - Tower prow unit with storage and fascia.

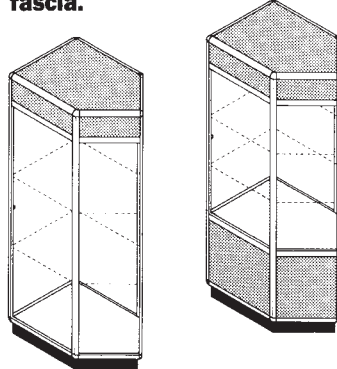

Unit ref.	Lights	No.	Watts
SQ TPF 06D	LVDL	4	80
" 06F	FLDF	2	30
SQ TPB 06D	LVDL	4	80
" 06F	FLDF	2	30

CPG - Counter prow unit fully glazed.

CPS - Counter prow unit with storage base.

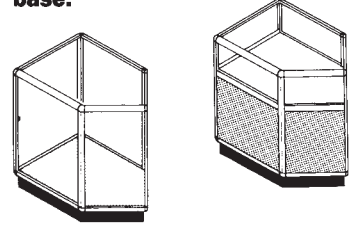

Unit ref.	Lamps	No.	Watts
SQ CPG 06A	-	-	-
" 06L	LVSL	2	40
SQ CPS 06A	-	-	-
" 06L	LVSL	2	40

STP - Shallow tank-top prow unit.
300mm high. No plinth.

DTP - Deep tank-top prow unit.
600mm high. No plinth.

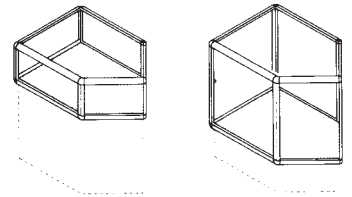

Unit ref.	Lamps	No.	Watts
SQ STP 06A	-	-	-
" 06L	LVSL	2	40
SQ DTP 06A	-	-	-
" 06L	LVSL	2	40

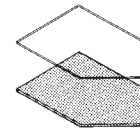

Shelves for prow units:
Glass - **SQ SHG 09P**
Timber - **SQ SHT 09P**

For dimensions see P2.

OFFSET-LINK UNITS



An offset unit allows the line of a run of units to be offset by 300mm – see page three. Unless specified otherwise, units are configured as illustrated: they can, however, be specified in reverse configuration by adding /R to the reference code.

TOG – Tower offset link fully glazed.

TOS – Tower offset link with storage base.

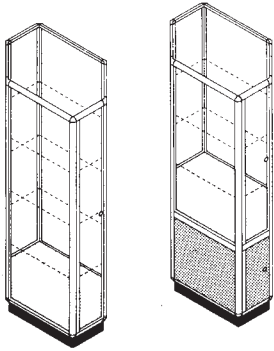

Unit ref.	Lamps	No.	Watts
SQ TOG 06A	–	–	–
" 06L	LVSL	4	80
SQ TOS 06A	–	–	–
" 06L	LVSL	4	80

TOF – Tower offset link glazed with fascia.

TOB – Tower offset link with storage and fascia.

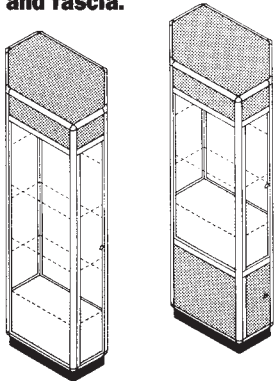

Unit ref.	Lights	No.	Watts
SQ TOF 06A	LVDL	4	80
" 06F	FLDF	2	30
SQ TOB 06A	LVDL	4	80
" 06F	FLDF	2	30

For dimensions see P2.

BAY-FRONT UNITS

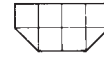

COG – Counter offset unit fully glazed.

COS – Counter offset unit with storage base.

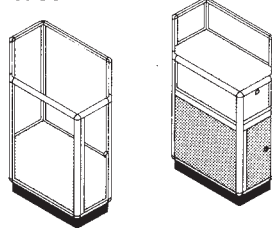

Unit ref.	Lamps	No.	Watts
SQ COG 06A	–	–	–
" 06L	LVSL	2	40
SQ COS 06A	–	–	–
" 06L	LVSL	2	40

STP – Shallow tank-top offset unit.

300mm high. No plinth.

DTO – Deep tank-top offset unit.

600mm high. No plinth.

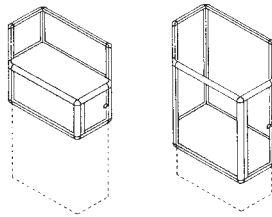

Unit ref.	Lamps	No.	Watts
SQ STO 06A	–	–	–
" 06L	LVSL	2	40
SQ DTO 06A	–	–	–
" 06L	LVSL	2	40

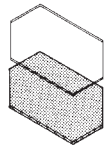

Shelf references for offset units:

Glass – **SQ SHG 09L**

Timber – **SQ SHT 09L**

WBG – Wall-standing bay-front fully glazed, Timber Rear.

WBS – Wall-standing bay-front glazed with storage base, Timber Rear.

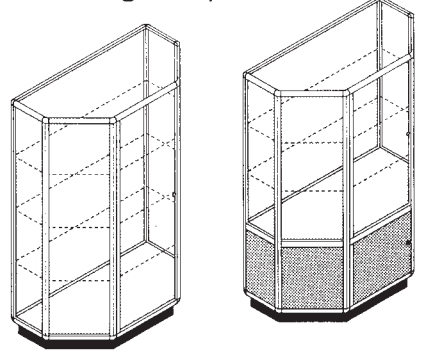

Unit ref.	Lights	No.	Watts
SQ WBG 12A	–	–	–
" 12L	LVSL	4	80
SQ WBS 12A	–	–	–
" 12L	LVSL	4	80

WBF – Wall-standing bay-front with fascia.

WBB – Wall-standing bay-front with storage and fascia.

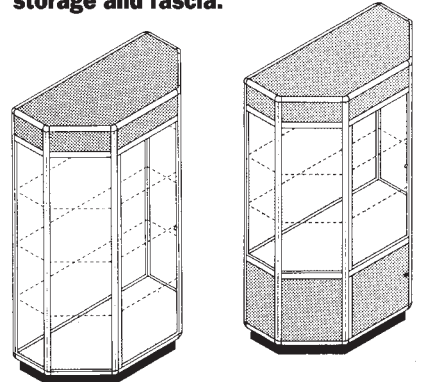

Unit ref.	Lights	No.	Watts
SQ WBF 12D	LVDL	4	80
" 12F	FLDF	2	36
SQ WBB 12D	LVDL	4	80
" 12F	FLDF	2	36

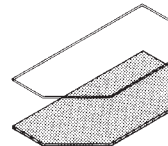

Shelves for bay-front units:

Glass – **SQ SHG 09F**

Timber – **SQ SHT 09F**

MUSHROOM UNITS



MUS - Mushroom case, no base storage.

900 x 900 x 260mm top section glazed with rolling doors. Panelled base section recessed 100mm. O/A height of unit 900mm.

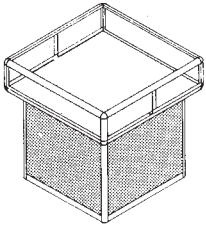

MUB - Mushroom case with storage base.

Similar to **MUS** unit, but with door and adjustable shelf in base section.

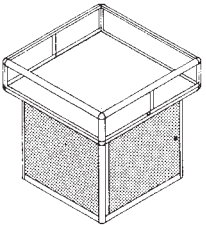

Unit ref.	Lamps	No.	Watts
SQ MUS 09S	-	-	-
" 09F	FLSH	1	18
SQ MUB 09S	-	-	-
" 09F	FLSH	1	18



MUT - Mushroom case, no base storage.

600 x 1200 x 260mm top section glazed with rolling doors. Panelled base section recessed 100mm. O/A height of unit 900mm.

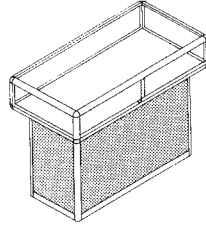

MUC - Mushroom case with storage base.

Similar to **MUT** unit, but with door and adjustable shelf in base section.

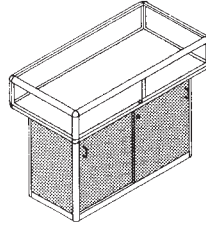

Unit ref.	Lamps	No.	Watts
SQ MUT 12S	-	-	-
" 12F	FLSH	1	30
SQ MUC 12S	-	-	-
" 12F	FLSH	1	30

SHELVES

Shelves for rectangular units.

The references below relate only to square-cut shelves: shelves for angled units are listed with the relevant units.

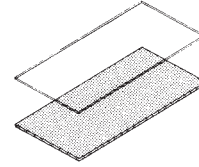

SHG - Glass shelves.

Float glass with polished edges and chamfered corners, 8mm thick (6mm for 600 width). Supplied with adjustable supports.

Unit ref.	Width	Depth
SQ SHG 06A	600	600
" 06B	"	300
" 12A	1200	600
" 12B	"	300
" 15A	1500	600
" 15B	"	300

SHT - Timber shelves.

Melamine-faced shelf with chamfered corners, 18mm thick. Supplied with adjustable supports.

Unit ref.	Width	Depth
SQ SHT 06A	600	600
" 12A	1200	"
" 15A	1500	"



The **Australian** Showcase Company



130 Broderick Road
Corio VIC 3214
Tel 03 5274 1133
Fax 03 5274 1199
Freecall 1800 805 842
www.clicksystems.com.au